

Think of
a clock
make dots
out - the
Big lines

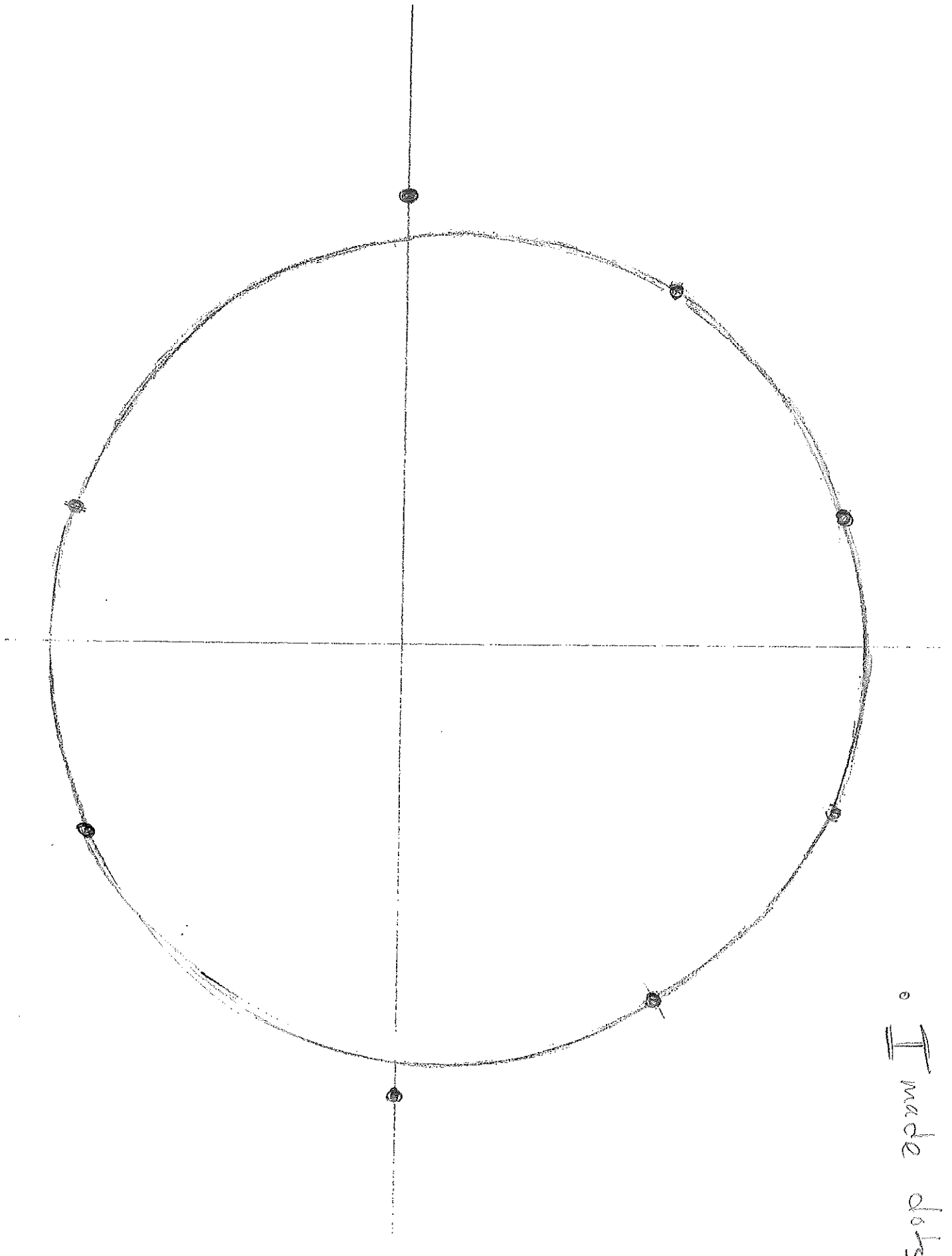

I made dots

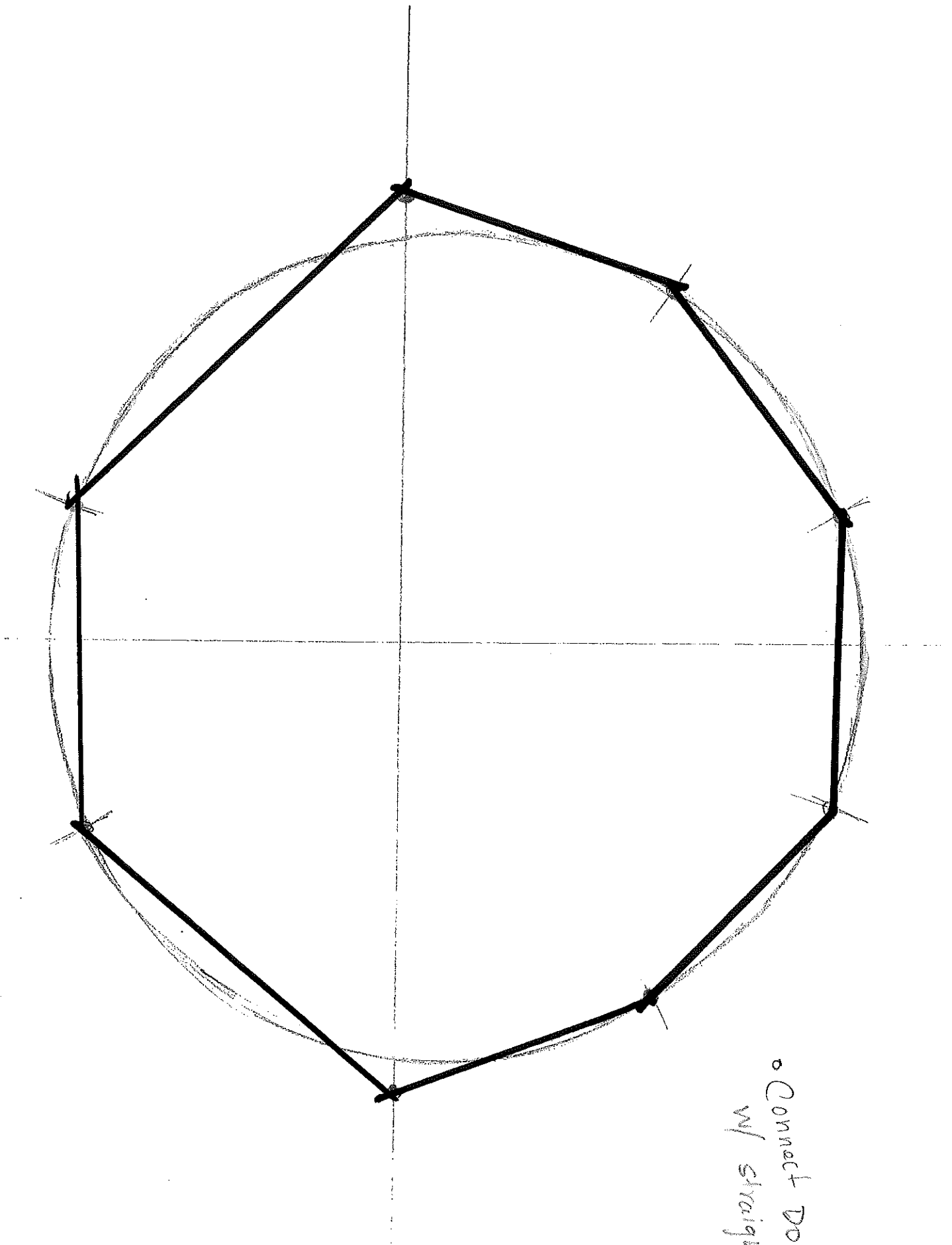

o Connect Dots
w/ straight lines

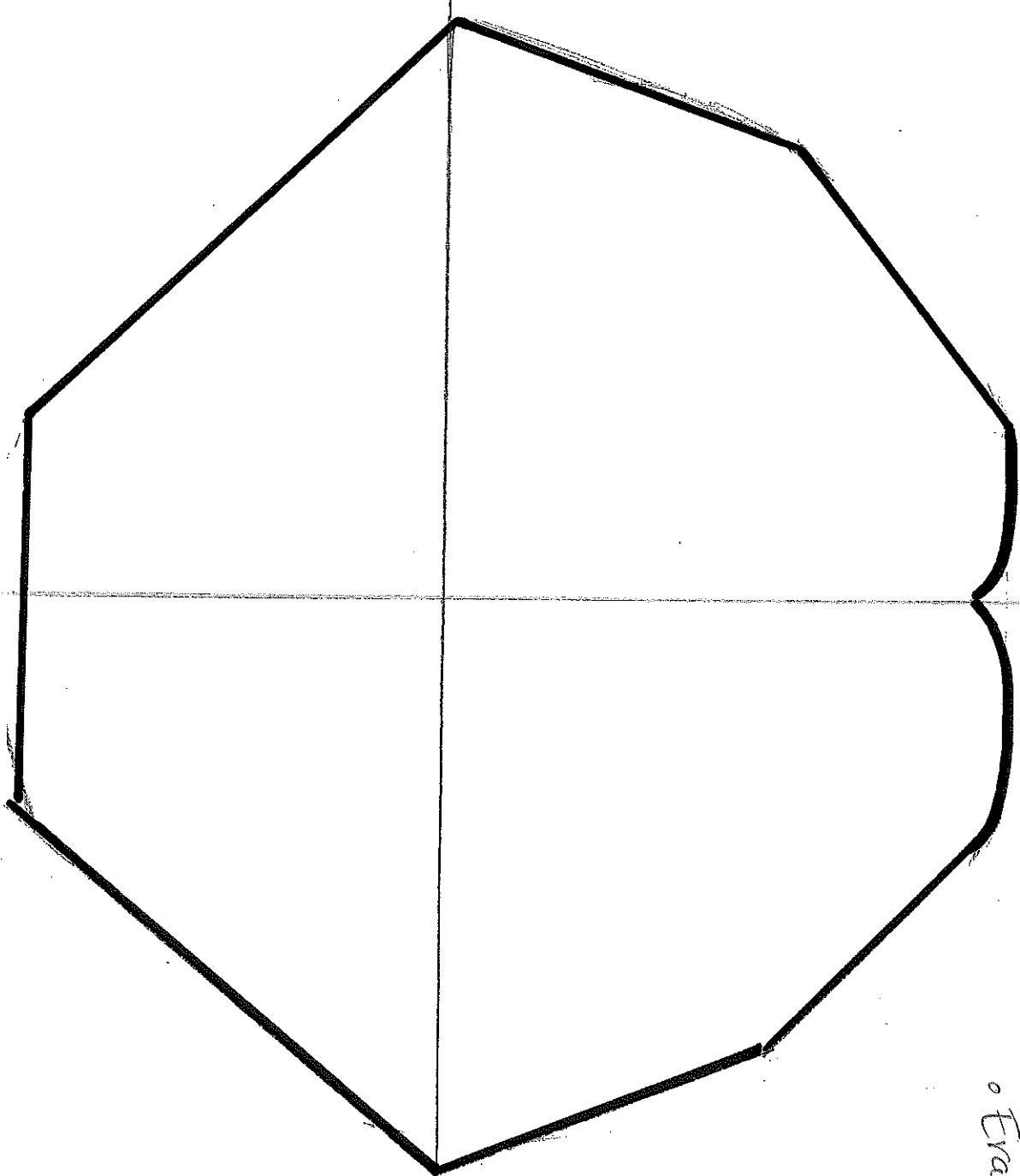

- Keeping ~~the~~ lines
- Erase circle

Wider
than
tall

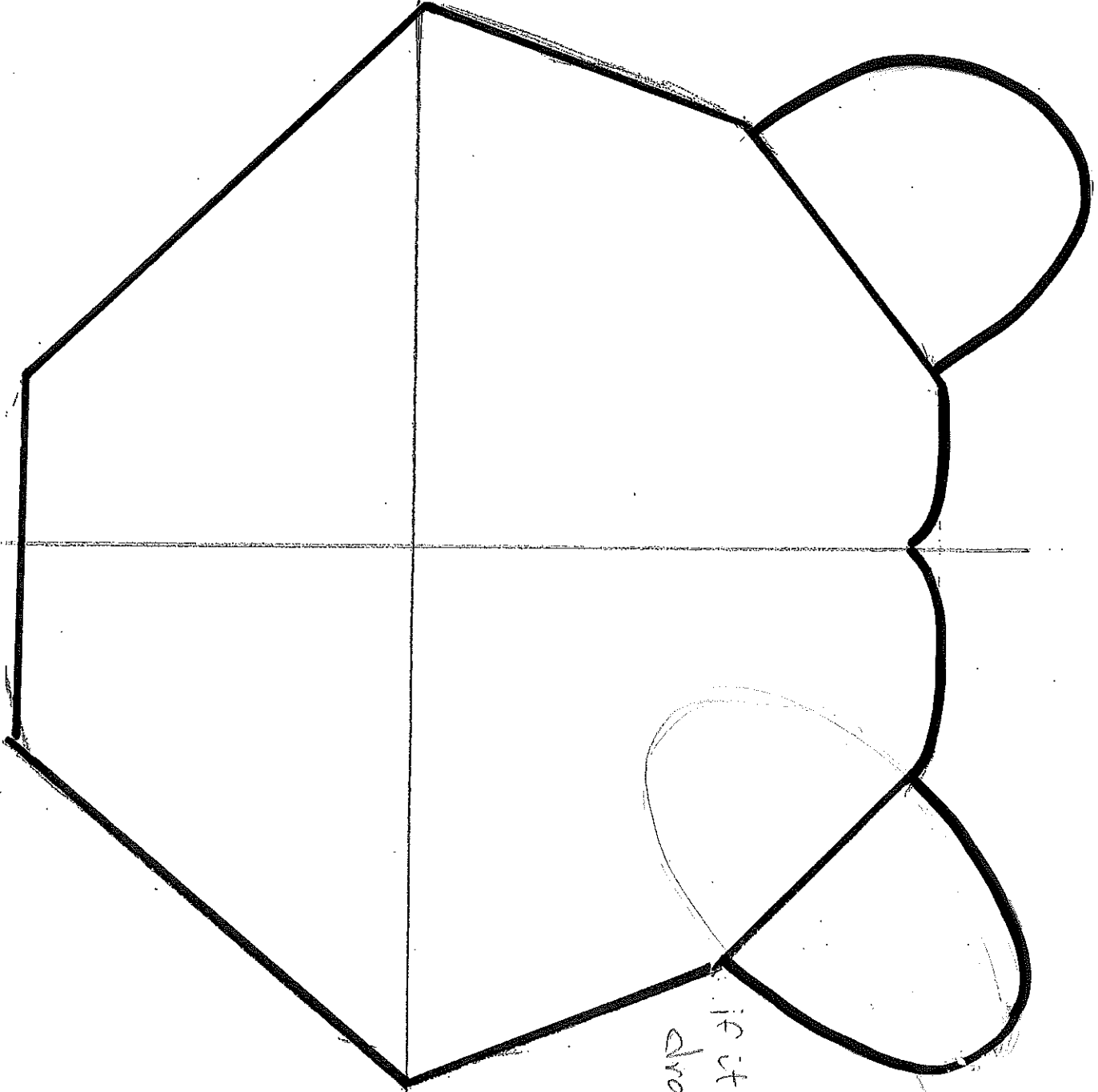

if it helps
draw a wide oval

Draw ears

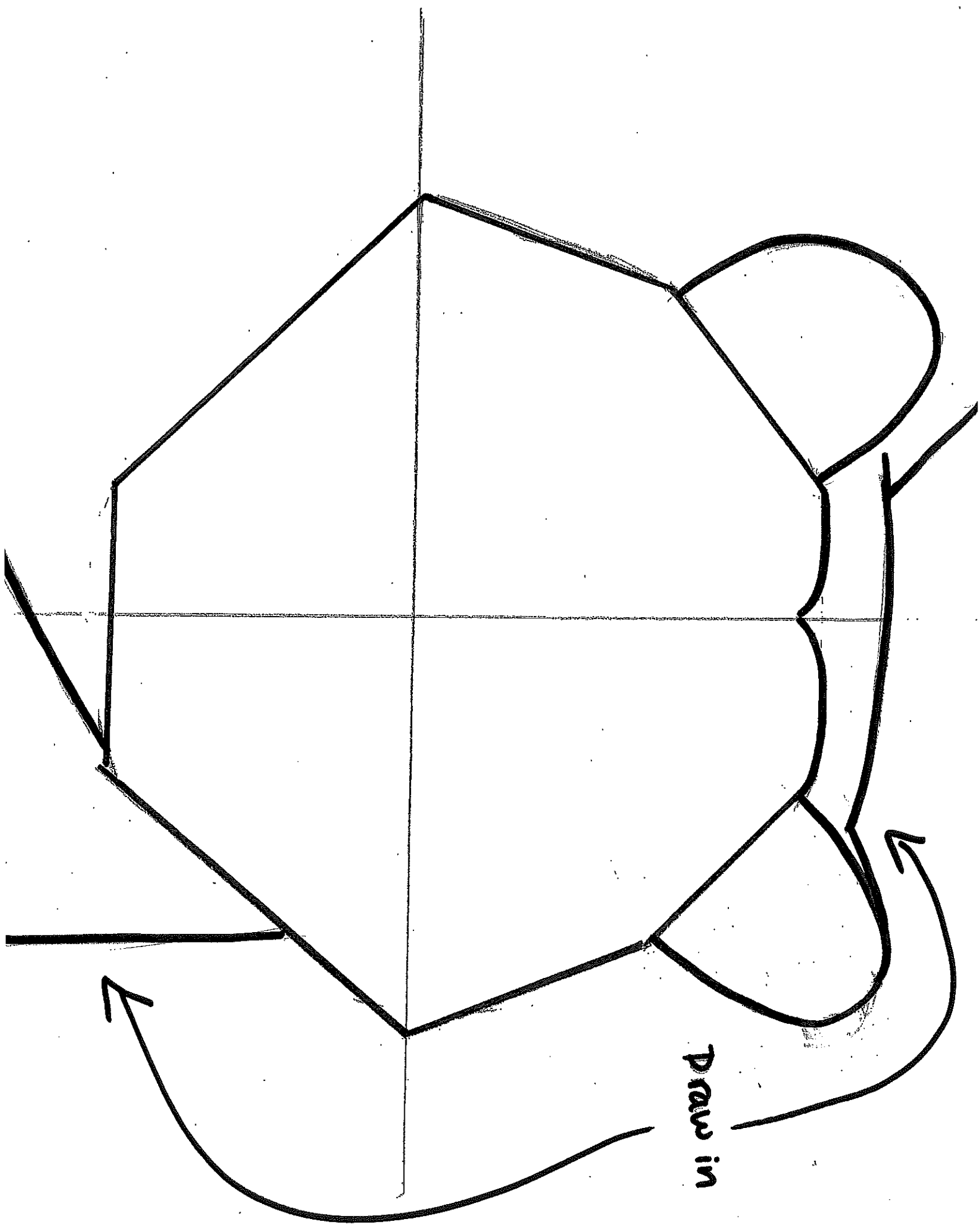

Draw in

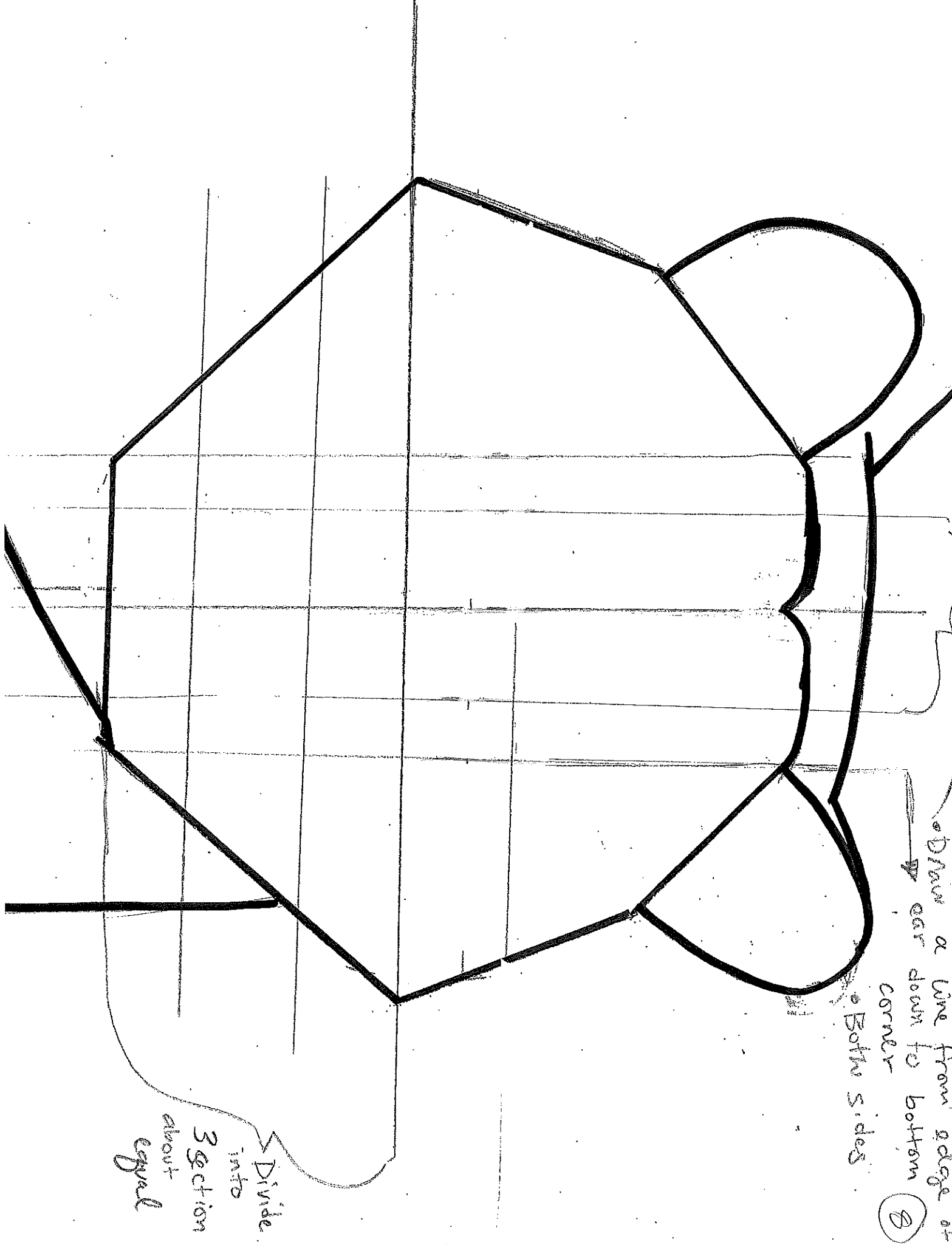

Draw a line from edge at corner
Both sides

Divide into 3 section about equal

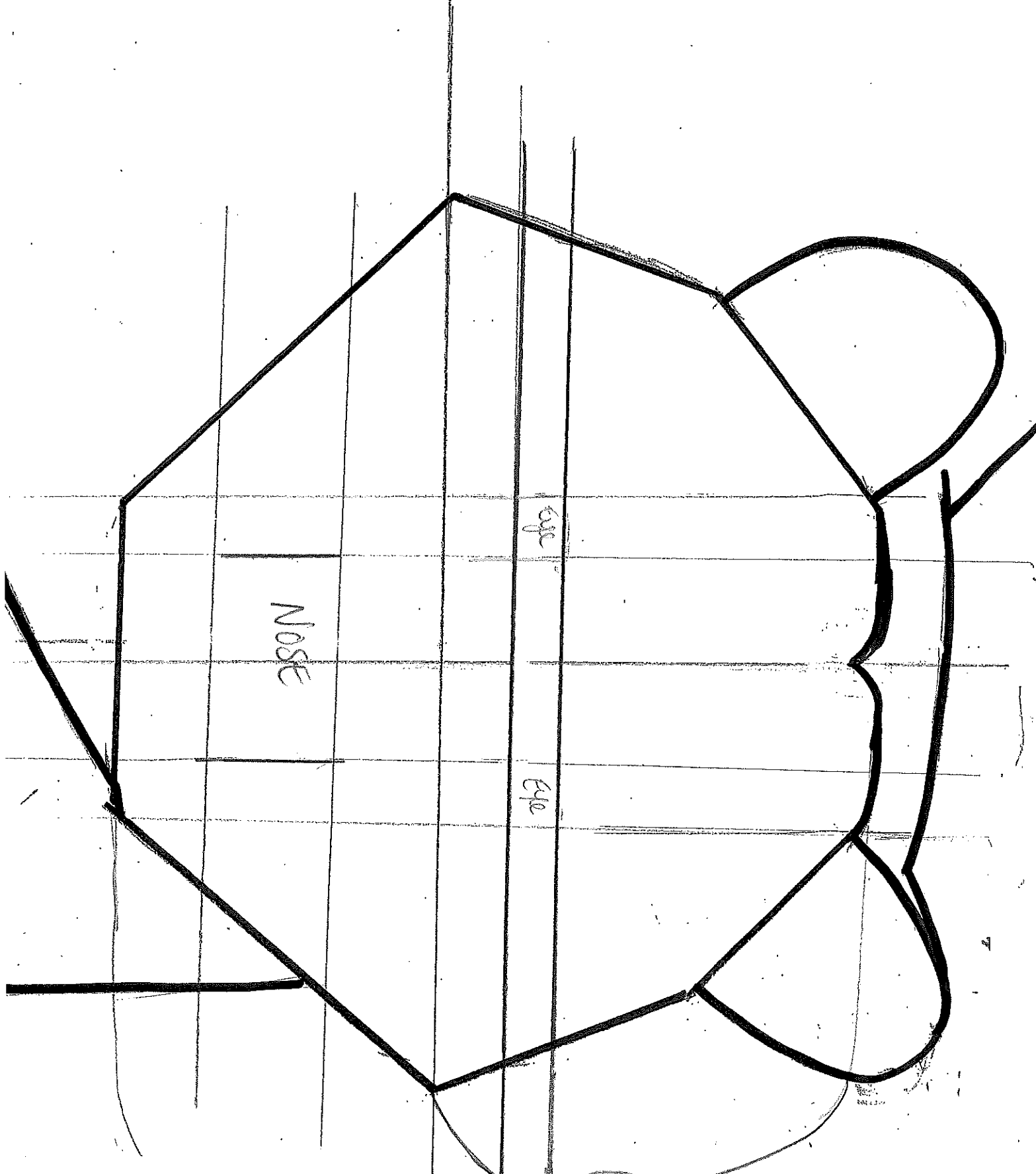

Nose

eye

eye

Make a line about
1/4 up
stomach
& on other
half
of
throat

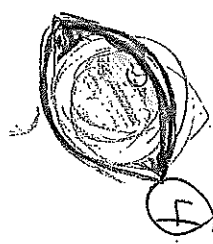
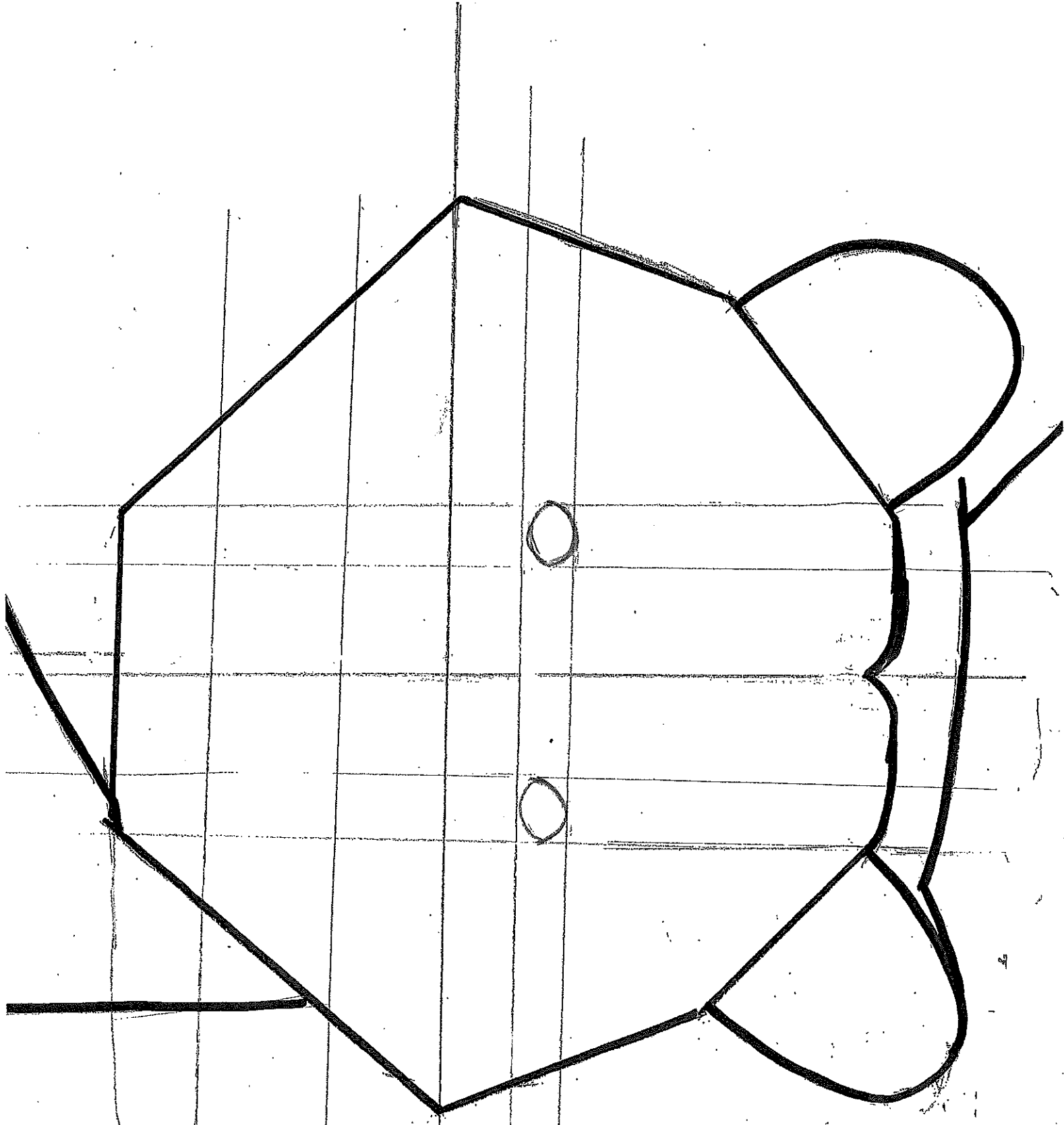

4

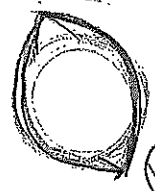

3

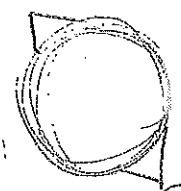

2

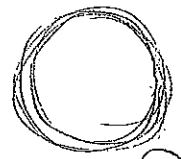

1

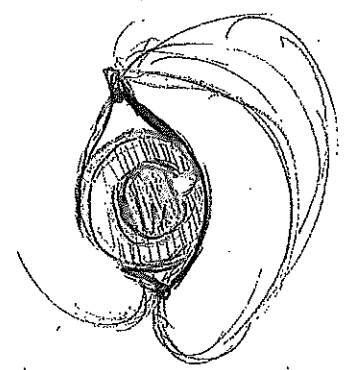

10

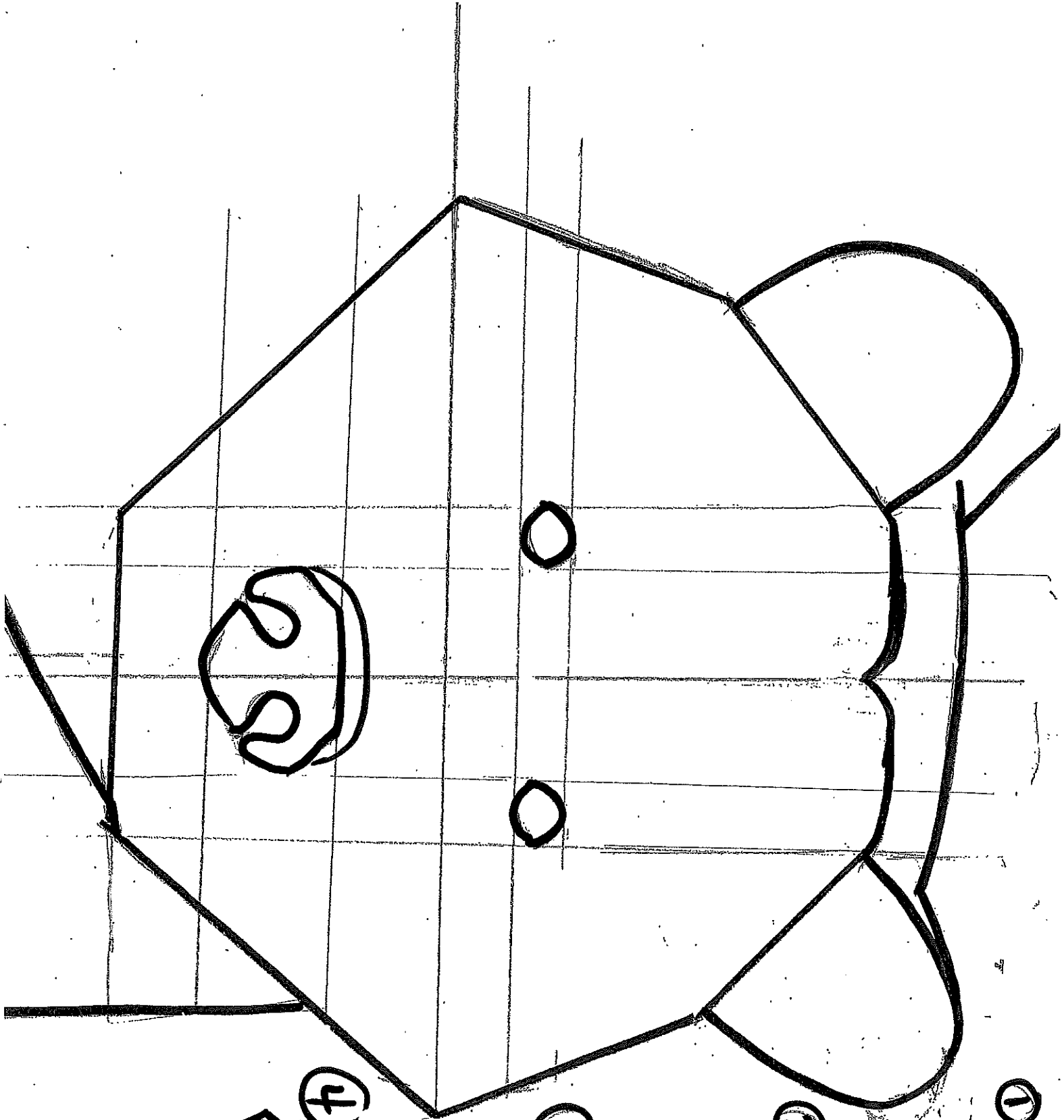

- ① A simple irregular polygon.
- ② A polygon with two small circles inside.
- ③ A polygon with two larger circles inside.
- ④ A polygon with two large, rounded, lobed shapes inside.

